

DIY Storage Chest

Free Plans

Little Bitti
living

Materials & Tools

MATERIALS:

- 1 | 4 x 8 Sheet of 3/4" Plywood
- 1 | 1x4 @ 6' long
- 1 | 1x6 @ 8' long
- 4 | 1/4" x 2 1/2" Premium Aspen boards @ 4' long
- 4 | Standard furniture feet
- 1 1/4" PH Screws
- 1 1/4" Finish Nails

TOOLS:

- Tape Measure
- Square
- Pencil
- Safety Glasses
- Hearing Protection
- Kreg Jig
- Nailer
- Drill
- Miter Saw
- Circular Saw
- Sander

CUTS:

Base

- 1 | Plywood sheet @ 36" x 17"

Sides

- 2 | Plywood sheets @ 17" x 15"

Front & Back

- 2 | Plywood sheets @ 34 1/2" x 15"

Trim

- 4 | 1/4" x 2-1/2" @ 10-3/4"
- 2 | 1/4" x 2 1/2" @ 36-1/2" long side with 45° perpendicular miter on each end
- 4 | 1/4" x 2-1/2" @ 17-1/4" long side with 45° perpendicular miter on each end

Lid

- 2 | 1 x 4 @ 26"
- 2 | 1 x 6 @ 26"
- 2 | 1 x 6 @ 18"

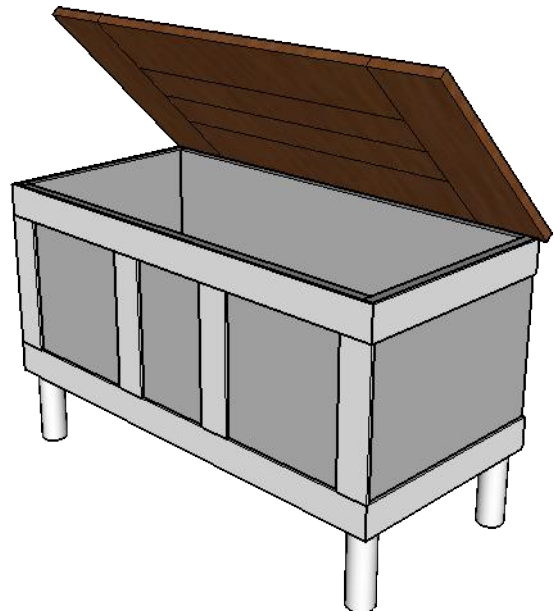

DIY Storage Chest

Free Plans

Little Bitti
living

GENERAL INSTRUCTIONS:

Please read through the entire plan and comments before beginning this project. Take all necessary precautions to build safely and smartly. Work on a clean level surface, free of imperfections or debris. Always use straight boards. Check for square after each step. Pre-drill holes before attaching with screws. Wipe excess wood glue off bare wood for stained projects, as dried glue will not stain.

STEP #1.

Start by attaching the sides of the bench to the base with 1-1/4" pocket hole screws and wood glue. The sides should sit flush with the outside edges of the base.

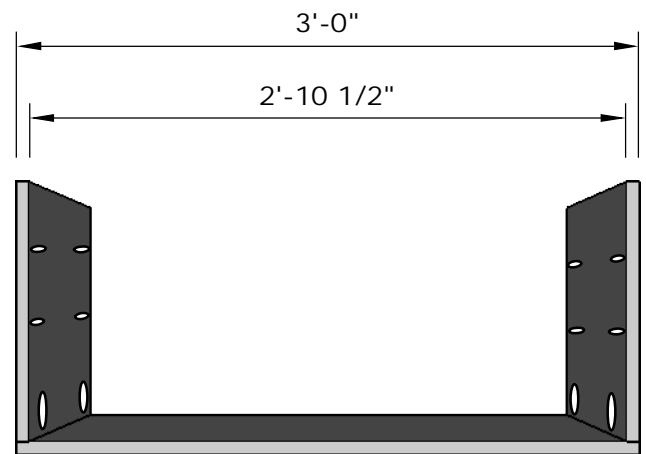
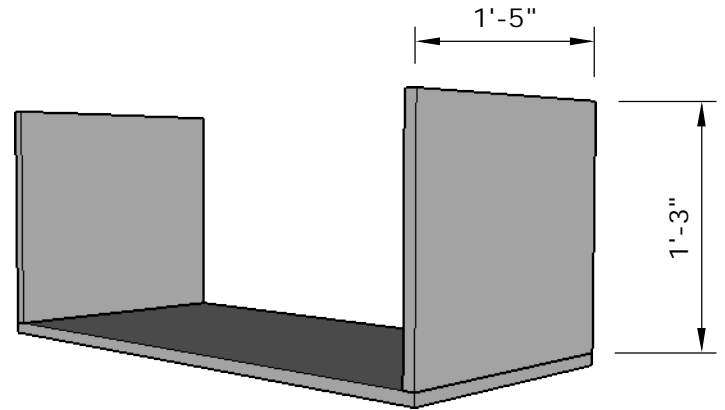

STEP #2.

Attach the front and back of the bench to the base and sides with 1-1/4" pocket hole screws and wood glue. The front and back should sit flush with the outer edges of the base and line up flush with the inside of the side pieces.

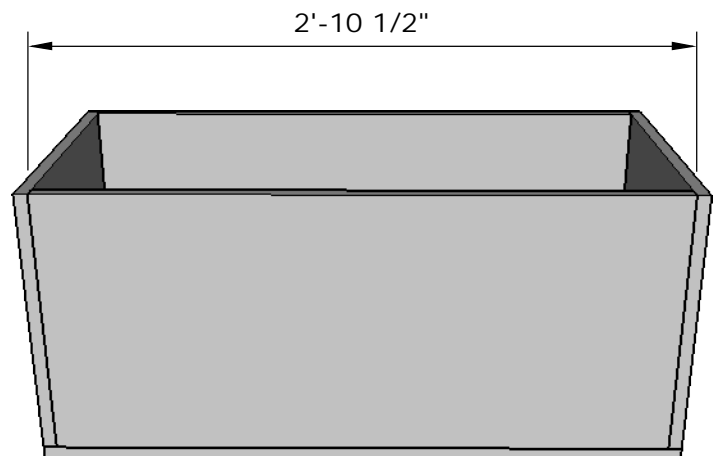

DIY Storage Chest

Free Plans

Little Bitti
living

STEP #3.

Attach the top and bottom trim to the bench with finish nails and wood glue. Position the trim so that it is flush with the top and bottom of the chest in order to cover up the plywood edges. Ensure the 45° trim miters are flush for a nice corner edge.

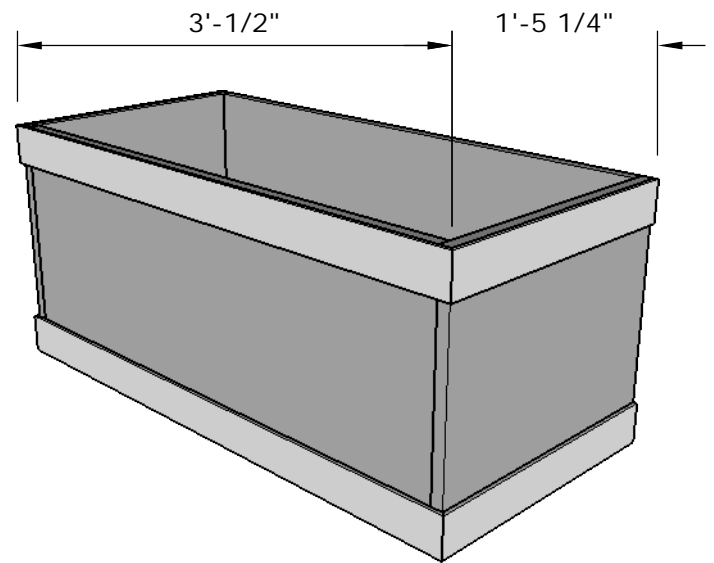

STEP #4.

Attach the front upright trim according to the dimensions shown with finish nails and wood glue. Position the trim so that it is flush with the top and bottom trim. Looking from the back, it should overhang the sides 1/4" when it is flush with the top and bottom trim pieces.

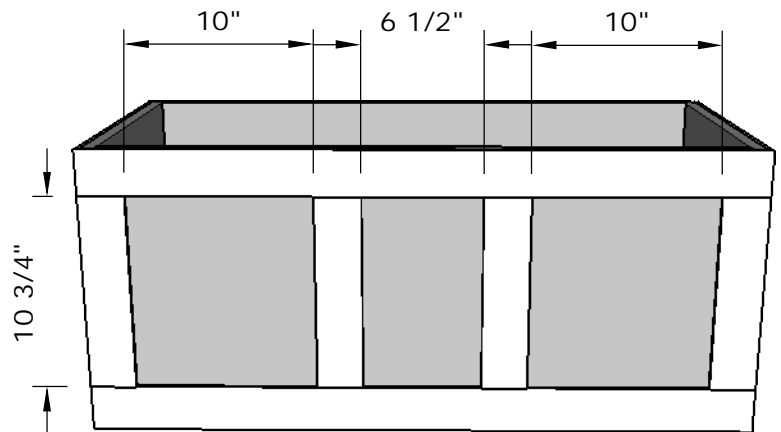

STEP #5.

Add the furniture feet. Most feet come with bolts in them for easy attachment. Pre-drill a hole according to the size of the bolts and screw into place. Use wood glue for extra strength.

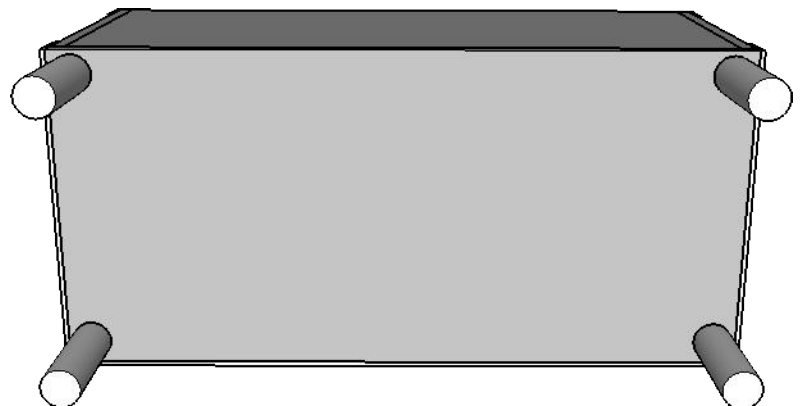

DIY Storage Chest

Free Plans

Little Bitti
living

STEP #6

Attach the storage chest lid with hinges at the back of the chest.

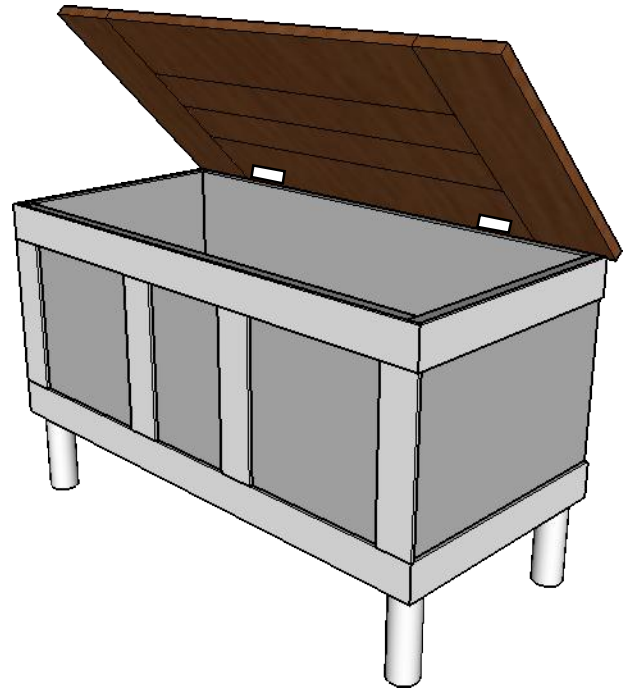

Chest Lid

To make the lid of the storage chest, attach the boards as shown on the right with wood glue and 1-1/4" pocket holes and screws. Attach at the bottom side of the lid to best hide the pocket holes.

